



Hi-Rel DC/DC CONVERTER MGDM-10 : 10W POWER

Hi-Rel
Grade ■■

Single, Bi & Triple Outputs
Metallic Case - 1.500 VDC Isolation



4

- 28Vdc input compliant with MIL-STD-704 D/E
- Low profile : 0,33 " (8.5mm)
- Nominal power of 10 W without derating
- Wide temperature range : -40°C/+105°C case
- High efficiency up to 83 %
- Soft start
- Galvanic isolation 1.500 VDC
- Integrated LC EMI filter
- Permanent short circuit protection
- Parallel operation master/slave
- No optocoupler for high reliability

1-General

The MGDM-10 series is a full family of high performance DC/DC low profile power modules designed for aerospace, military and high-end industrial applications. These modules use a high frequency fixed switching technic at 480 KHz providing excellent reliability, low noise characteristics, high power density and a low profile package. Standard models are available with nominal input voltages as 5, 12 or 28 volts in range of 4,5-5,5 9-36 or 16-40 volts. The series include single bi and triple output voltage choices of 3,3, 5, 12, 15, +/-5, +/-12, +/-15 or +/-24 volts. No external heatsink is required for the MGDM-10 series to supply 10W output power over the case temperature range of -40°C up to 105°C.

All the modules are designed with LC network filters to minimize reflected input current ripple and output voltage ripple.

The modules include a soft-start, an input undervoltage lock-out, a permanent short circuit protection and an output overvoltage protection to ensure efficient module protections.

The soft-start allows current limitation and eliminates inrush current during start-up. The short circuit protection completely protects the module against short-circuits of any duration by a shut-down and restores to normal when the overload is removed.

The design has been carried out with surface mount components and is manufactured in a fully automated process to guarantee high quality. Each module is tested and burned in with a GAIA Converter automated test equipment before and after encapsulation. The modules are potted with an excellent thermal conductive compound and packaged in a metallic case to ensure the module's integrity under high temperature conditions.

2-Product Selection

Master converter :

Single output model : MGDS-10- — (/T) and/or (/S)

Bi output model : MGDB-10- — (/T) and/or (/S)

Triple output model : MGDT-10- — (/T) and/or (/S)

Slave converter :

Single output model : MGDE-10- — (/T) and/or (/S)

(/T) : option for -55°C start up operating temperature.

(/S) : option for screening and serialization

Input Voltage Range	
Permanent	Transient
C : 4,5-5,5 VDC	n/a
H : 9-36 VDC	40 VDC/100 ms*
J : 16-40 VDC	50 VDC/100 ms*

Output
B : 3.3 VDC
C : 5 VDC or +/-5VDC
E : 12 VDC or +/-12VDC
F : 15 VDC or +/-15VDC
CE : 5 VDC and +/-12 VDC
CF : 5 VDC and +/-15 VDC
I : +/-24 VDC

* Consult factory for details

REDEFINING THE SOURCE OF POWER

© Gaia Converter FC97-010.08/06 Revision P

For locations, phone, fax, E-Mail see back cover

2- Product Selection (continued)

Input range	Output	Current	Reference	Options
4,5-5,5 VDC	3,3 VDC	2 A	MGDS-10-C-B	/T , /S
4,5-5,5 VDC	5 VDC	2 A	MGDS-10-C-C	/T , /S
4,5-5,5 VDC	12 VDC	0,800 A	MGDS-10-C-E	/T , /S
4,5-5,5 VDC	15 VDC	0,650 A	MGDS-10-C-F	/T , /S
4,5-5,5 VDC	+/- 5 VDC	+/- 1 A	MGDB-10-C-C	/T , /S
4,5-5,5 VDC	+/- 12 VDC	+/- 0,400 A	MGDB-10-C-E	/T , /S
4,5-5,5 VDC	+/- 15 VDC	+/- 0,330 A	MGDB-10-C-F	/T , /S
9-36 VDC	3,3 VDC	2 A	MGDS-10-H-B	/T , /S
9-36 VDC	5 VDC	2 A	MGDS-10-H-C	/T , /S
9-36 VDC	12 VDC	0,800 A	MGDS-10-H-E	/T , /S
9-36 VDC	15 VDC	0,650 A	MGDS-10-H-F	/T , /S
9-36 VDC	+/- 5 VDC	+/- 1 A	MGDB-10-H-C	/T , /S
9-36 VDC	+/- 12 VDC	+/- 0,400 A	MGDB-10-H-E	/T , /S
9-36 VDC	+/- 15 VDC	+/- 0,330 A	MGDB-10-H-F	/T , /S
9-36 VDC	5 & +/- 12 VDC	1 A & +/-0,20 A	MGDT-10-H-CE	/T , /S
9-36 VDC	5 & +/- 15 VDC	1 A & +/- 0,15 A	MGDT-10-H-CF	/T , /S
16-40 VDC	3,3 VDC	2 A	MGDS-10-J-B	/T , /S
16-40 VDC	5 VDC	2 A	MGDS-10-J-C	/T , /S
16-40 VDC	12 VDC	0,800 A	MGDS-10-J-E	/T , /S
16-40 VDC	15 VDC	0,650 A	MGDS-10-J-F	/T , /S
16-40 VDC	+/- 5 VDC	+/- 1 A	MGDB-10-J-C	/T , /S
16-40 VDC	+/- 12 VDC	+/- 0,400 A	MGDB-10-J-E	/T , /S
16-40 VDC	+/- 15 VDC	+/- 0,330 A	MGDB-10-J-F	/T , /S
16-40 VDC	+/- 24 VDC	+/- 0,200 A	MGDB-10-J-I	/T , /S
16-40 VDC	5 & +/- 12 VDC	1 A & +/-0,20 A	MGDT-10-J-CE	/T , /S
16-40 VDC	5 & +/- 15 VDC	1 A & +/- 0,15 A	MGDT-10-J-CF	/T , /S

4

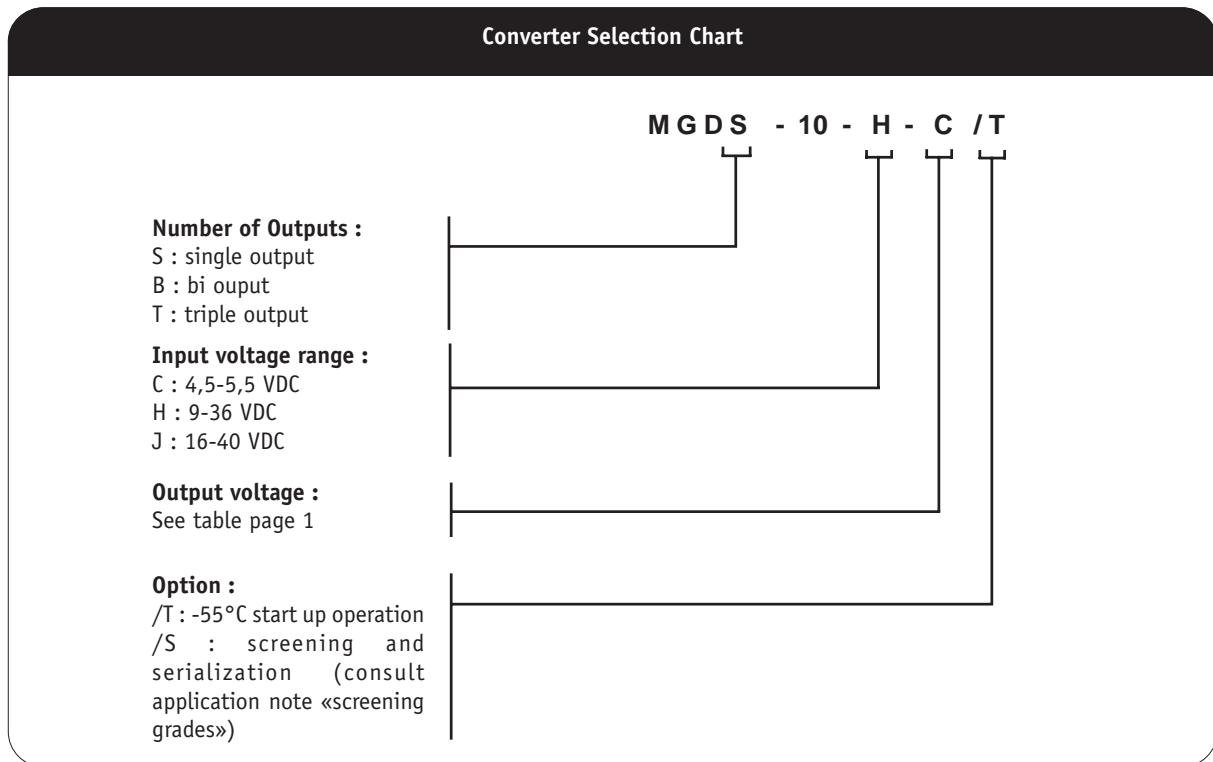

3- Electrical Specifications

Data are valid at +25°C, unless otherwise specified.

Parameter	Conditions	Limit or typical	Units	Single Output MGDS-10		
				10-C	10 - H	10 - J
Input						
Nominal input voltage	Full temperature range	Nominal	VDC	5	20	28
Permanent input voltage range (Ui)	Full temperature range	Min. - Max.	VDC	4,5-5,5	9-36	16-40
Extended permanent input voltage range	Full temperature range (Consult factory)	Min. - Max.	VDC	/	/	16-45
Transient input voltage	Full load (Consult factory)	Maximum	VDC/S	/	40/0,1	50/0,1
Undervoltage lock-out (UVLO)	turn-on/turn-off threshold	Minimum	VDC	4	7	12
		Maximum	VDC	4,3	8,5	15
Start up time	Ui nominal Nominal output Full load : resistive	Maximum	ms	30	30	30
Reflected ripple current	Ui nominal, full load at switching freq. BW = 20MHz	Maximum	mApp	50	50	30
Input current in short circuit mode (Average)	Ui nominal Short-circuit	Maximum	mA	50	30	30
No load input current	Ui nominal No load	Maximum	mA	50	30	30
Output						
Output voltage *	Full temperature range	Nominal	VDC	3,3	3,3	3,3
	Ui min. to max.	Nominal	VDC	5	5	5
	75% load	Nominal	VDC	12	12	12
		Nominal	VDC	15	15	15
Set Point accuracy	Ambient temperature : +25°C Ui nominal, 75% load	Maximum	%	+/- 2	+/- 2	+/- 2
Output power	Full temperature range Ui min. to max.	Maximum	W	10	10	10
Output current **	Full temperature range Ui min. to max.	Maximum	A	2	2	2
3,3V output		Maximum	A	2	2	2
5V output		Maximum	A	0,80	0,80	0,80
12V output		Maximum	A	0,65	0,65	0,65
15V output		Maximum	A	0,65	0,65	0,65
Ripple output voltage ***	Ui nominal	Maximum	mVpp	40	40	40
3,3V and 5V output	Full load	Maximum	mVpp	50	50	50
12V output	BW = 20MHz	Maximum	mVpp	60	60	60
15V output		Maximum	mVpp	60	60	60
Line regulation	Ui min. to max. Full load	Maximum	%	+/- 1	+/- 1	+/- 1
Load regulation ****	Ui nominal 25% to full load	Maximum	%	+/- 2,5	+/- 2,5	+/- 2,5
Efficiency	Ui nominal Full load	Typical	%	See on page 6		
Maximum admissible Capacity load	Ui nominal	Maximum	µF	1.000	1.000	1.000
3,3V and 5V output	Full load	Maximum	µF	330	330	330
12V and 15V output	Per output					

Note * : For proper operation the MGDM-10 module requires to install a 22µF chemical or tantalum capacitance across output terminals.

Note ** : For 9-36V input range, the current is derated at 80% at 9V and increases linearly to full current at 12V.

Note*** : The ripple output voltage is the periodic AC component imposed on the output voltage, an aperiodic and random component (noise) has also to be considered. This noise can be reduced by adding an external capacitor (typically 10nF/rated voltage depending on isolation requirement) connected between the pin Gin and the pin Gout of the converter. This capacitor should be layed-out as close as possible from the converter.

Note**** : For load regulation characteristics from 0% to full load, please see page 6.

3- Electrical Characteristics (continued)

Data are valid at +25°C, unless otherwise specified.

Parameter	Conditions	Limit or typical	Units	Bi Output MGDB-10		
				10-C	10 - H	10 - J
Input						
Nominal input voltage	Full temperature range	Nominal	VDC	5	20	28
Permanent input voltage range (Ui)	Full temperature range	Min. - Max.	VDC	4,5-5,5	9-36	16-40
Extended permanent input voltage range	Full temperature range (Consult factory)	Min. - Max.	VDC	/	/	16-45
Transient input voltage	Full load (Consult factory)	Maximum	VDC/S	/	40/0,1	50/0,1
Undervoltage lock-out (UVLO)	Turn-on/turn-off threshold	Minimum	VDC	4	7	12
		Maximum	VDC	4,3	8,5	15
Start up time	Ui nominal Nominal output Full load : resistive	Maximum	ms	30	30	30
Reflected ripple current	Ui nominal, full load at switching freq. BW = 20MHz	Maximum	mApp	50	50	30
Input current in short circuit mode (Average)	Ui nominal Short-circuit	Maximum	mA	50	30	30
No load input current	Ui nominal No load	Maximum	mA	50	30	30
Output						
Output voltage *	Full temperature range Ui min. to max. 75% load	Nominal	VDC	+/- 5	+/- 5	+/- 5
		Nominal	VDC	+/- 12	+/- 12	+/- 12
		Nominal	VDC	+/- 15	+/- 15	+/- 15
		Nominal	VDC	/	/	+/- 24
Set Point accuracy	Ambient temperature : +25°C Ui nominal, 75% load	Maximum	%	+/- 2	+/- 2	+/- 2
Output power	Full temperature range Ui min. to max.	Maximum	W	+/- 5	+/- 5	+/- 5
Output current **	Full temperature range Ui min. to max.	Maximum	A	+/- 1	+/- 1	+/- 1
		Maximum	A	+/- 0,40	+/-0, 40	+/-0, 40
		Maximum	A	+/- 0,33	+/- 0,33	+/- 0,33
		Maximum	A	/	/	+/-0,20
		Maximum	A	/	/	+/-0,20
Ripple output voltage ***	Ui nominal Full load BW = 20MHz	Maximum	mVpp	40	40	40
		Maximum	mVpp	50	50	50
		Maximum	mVpp	60	60	60
		Maximum	mVpp	60	60	60
Line regulation	Ui min. to max. Full load	Maximum	%	+/- 1	+/- 1	+/- 1
Load regulation ****	Ui nominal 25% to full load	Maximum	%	+/- 2,5	+/- 2,5	+/- 2,5
Cross load output regulation	Ui nominal + Vout nominal load - Vout from 25% to full load	Maximum	%	+/- 0,5	+/- 0,5	+/- 0,5
Efficiency	Ui nominal Full load	Typical	%	See on page 6		
Maximum admissible Capacity load	Ui nominal Full load Per output	Maximum	µF	470	470	470
		Maximum	µF	100	100	100
		Maximum	µF	100	100	100

Note * : For proper operation the MGDM-10 module requires to install a 22µF chemical or tantalum capacitance across output terminals.

Note ** : For 9-36V input range, the current is derated at 80% at 9V and increases linearly to full current at 12V.

Note*** : The ripple output voltage is the periodic AC component imposed on the output voltage, an aperiodic and random component (noise) has also to be considered. This noise can be reduced by adding an external capacitor (typically 10nF/rated voltage depending on isolation requirement) connected between the pin Gin and the pin Gout of the converter. This capacitor should be layed-out as close as possible from the converter.

Note**** : For load regulation characteristics from 0% to full load, please see page 6.

3- Electrical Characteristics (continued)

Data are valid at +25°C, unless otherwise specified.

Parameter	Conditions	Limit or typical	Units	Tri Output MGDT-10	
				10 - H	10 - J
Input					
Nominal input voltage	Full temperature range	Nominal	VDC	20	28
Permanent input voltage range (Ui)	Full temperature range	Min. - Max.	VDC	9-36	16-40
Extended permanent input voltage range	Full temperature range (Consult factory)	Min. - Max.	VDC	/	16-45
Transient input voltage	Full load	Maximum	VDC/S	40/0,1	50/0,1
Undervoltage lock-out (UVLO)	Turn-on/turn-off threshold	Minimum	VDC	7	12
		Maximum	VDC	8,5	15
Start up time	Ui nominal Nominal output Full load : resistive	Maximum	ms	30	30
Reflected ripple current	Ui nominal, full load at switching freq. BW = 20MHz	Maximum	mApp	50	30
Input current in short circuit mode (Average)	Ui nominal Short-circuit	Maximum	mA	30	30
No load input current	Ui nominal No load	Maximum	mA	30	30
Output					
Output voltage *	Full temperature range Ui min. to max. 75% load	Nominal	VDC	5 & +/- 12	5 & +/- 12
		Nominal	VDC	5 & +/- 15	5 & +/- 15
Set Point accuracy	Ambient temperature : +25°C Ui nominal, 75% load	Maximum	%	+/- 2	+/- 2
Output power	Full temperature range Ui min. to max.	Maximum	W	5 & +/- 2,5	5 & +/- 2,5
Output current **	Full temperature range Ui min. to max.	Maximum	A	1 & +/- 0,20	1 & +/- 0,20
		Maximum	A	1 & +/- 0,15	1 & +/- 0,15
Ripple output voltage ***	Ui nominal	Maximum	mVpp	40	40
	Full load	Maximum	mVpp	50	50
	12V output	Maximum	mVpp	60	60
	15V output	Maximum	mVpp	60	60
Line regulation	Ui min. to max. Full load	Maximum	%	+/- 1	+/- 1
Load regulation ****	Ui nominal 25% to full load	Maximum	%	+/- 2,5	+/- 2,5
Cross load output regulation	Ui nominal + Vout nominal load - Vout from 25% to full load	Maximum	%	+/- 0,5	+/- 0,5
Efficiency	Ui nominal Full load	Typical	%	82	82
Maximum admissible Capacity load	Ui nominal	Maximum	μF	470	470
	Full load	Maximum	μF	100	100
	Per output	Maximum	μF	100	100

Note * : For proper operation the MGDM-10 module requires to install a 22μF chemical or tantalum capacitance across output terminals.

Note ** : For 9-36V input range, the current is derated at 80% at 9V and increases linearly to full current at 12V.

Note*** : The ripple output voltage is the periodic AC component imposed on the output voltage, an aperiodic and random component (noise) has also to be considered. This noise can be reduced by adding an external capacitor (typically 10nF/rated voltage depending on isolation requirement) connected between the pin Gin and the pin Gout of the converter. This capacitor should be layed-out as close as possible from the converter.

Note**** : For load regulation characteristics from 0% to full load, please see page 6.

3- Electrical Characteristics (continued)

Figure 1 : Typical efficiency versus load at nominal input

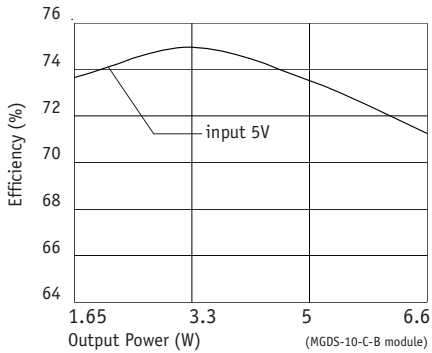

Figure 2 : Typical efficiency versus load at nominal input

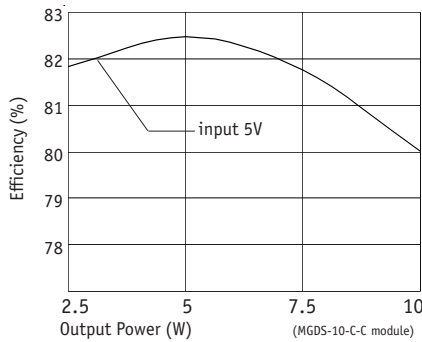

Figure 3 : Typical efficiency versus load at nominal input

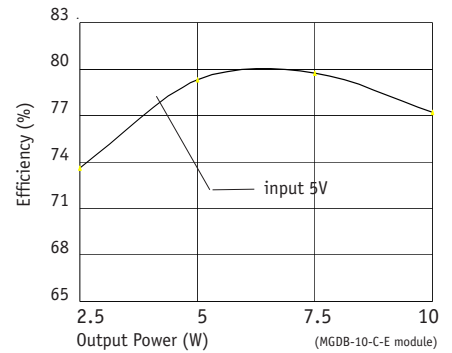

Figure 4 : Typical efficiency versus load at nominal input

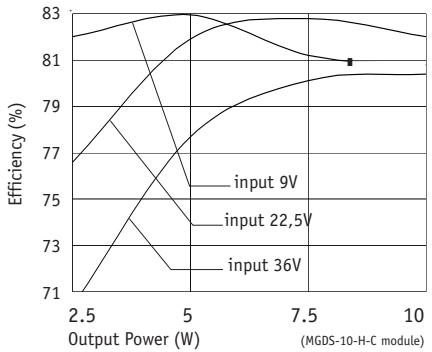

Figure 5 : Typical efficiency versus load at nominal input

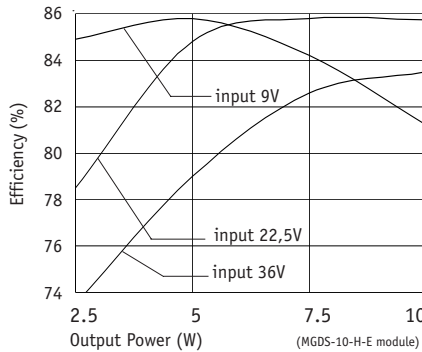

Figure 6 : Typical efficiency versus load at nominal input

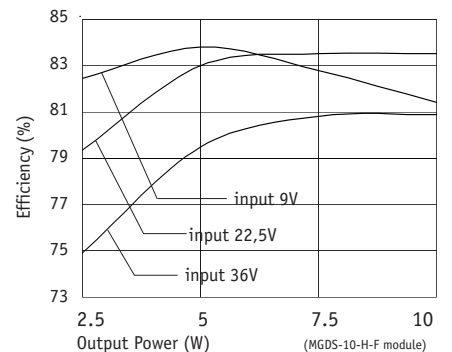

Figure 7 : Typical efficiency versus load at various input

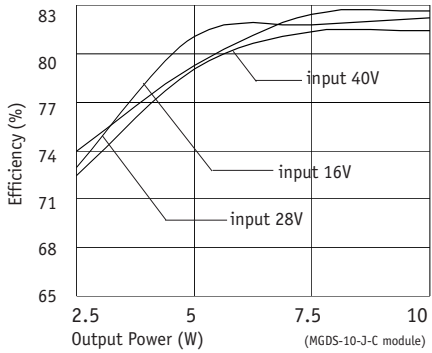

Figure 8 : Typical efficiency versus load at various input

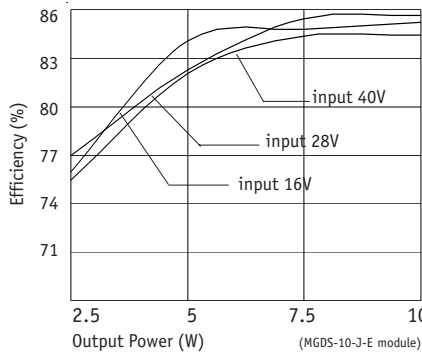

Figure 9 : Typical efficiency versus load at various input

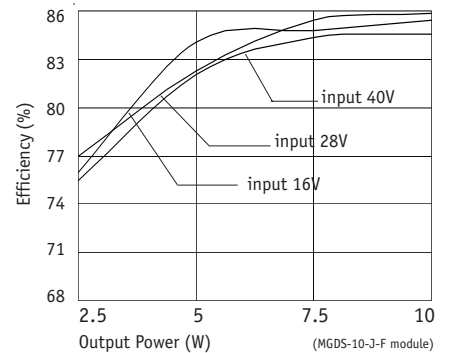

Figure 10 : Typical load regulation characteristics at nominal input

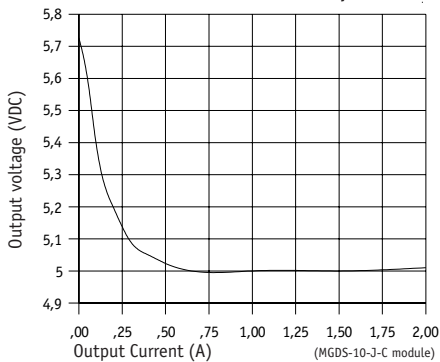

Figure 11 : Typical load regulation characteristics at nominal input

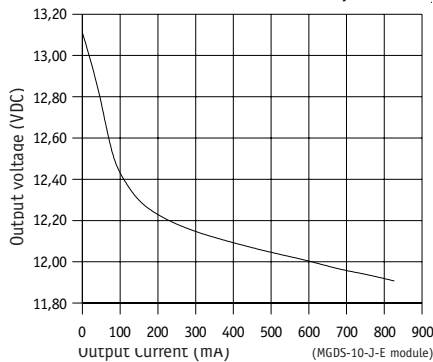
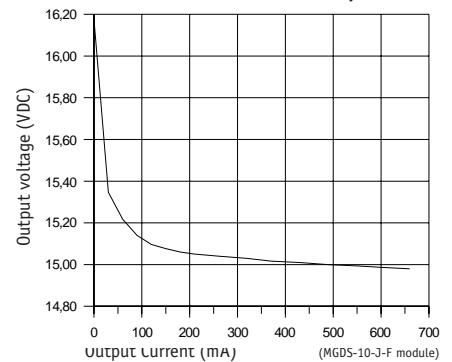

Figure 12 : Typical load regulation characteristics at nominal input



4- Switching Frequency

Parameter	Conditions	Limit or typical	Specifications
Switching frequency	Full temperature range Ui min. to max. No load to full load	Nominal, fixed	480 KHz

5- Isolation

Parameter	Conditions	Limit or typical	Specifications
Electric strength test voltage	Input to output	Minimum	1.500 VDC / 1 min
Electric strength test voltage between outputs (for dual and triple outputs)	Output to output	Minimum	No isolation
Isolation resistance	500 VDC	Minimum	100 MOhm

6- Protection Functions

Characteristics	Protection Device	Recovery	Limit or typical	Specifications
Input undervoltage lock-out (UVLO)	Turn-on, turn-off circuit with no hysteresis	Automatic recovery	Threshold	See section 3
Output short circuit protection (SCP)	Hiccup circuitry with auto-recovery	Automatic recovery	Permanent	See section 11
Output overvoltage protection (OVP)	Zener clamp	/	Maximum Maximum Maximum Maximum	For 3.3v : 4v For 5v : 6v For 12v : 14v For 15v : 17v

7- Reliability Data

Characteristics	Conditions	Temperature	Specifications
Mean Time Between Failure (MTBF) According to MIL-HDBK-217F	Ground fixed (Gf)	Case at 40°C Case at 85°C	965.000 Hrs 385.000 Hrs
	Airborne, Inhabited, Cargo (AIC)	Case at 40°C Case at 85°C	500.000 Hrs 180.000 Hrs
Mean Time Between Failure (MTBF) According to IEC-62380-TR	Avionics Military Cargo	/	Consult factory

8- Electromagnetic Interference

Electromagnetic Interference requirements according to MIL-STD-461C/D/E standards can be easily achieved as indicated in the following section. The following table resumes the different sections covered by these standards.

Standard Requirements	MIL-STD-461C Standard	MIL-STD-461D/E Standard	Compliance with GAIA Converter Module & common mode capacitance
Conducted emission (CE) : Low frequency High frequency	CE 01 CE 03	CE 101 CE 102	compliant module stand-alone compliant with additional filter
Conducted susceptibility (CS) : Low frequency High frequency	CS 01 CS 02	CS 101 CS114	compliant with additional filter compliant with additional filter
Radiated emission (RE) : Magnetic field Electrical field	RE 01 RE 02	RE 101 RE 102	compliant module stand-alone compliant module stand-alone
Radiated susceptibility (RS) : Magnetic field Electrical field	RS 01 RS 03	RS 101 RS 103	compliant module stand-alone compliant module stand-alone
Applicability	H, J input module	H, J input module	see EMI datasheet

8-1 Module Compliance with MIL-STD-461C/D/E Standards

To meet the latest US military standards MIL-STD-461D/E (and also the MIL-STD-461C) requirements and in particular the conducted noise emission CE102 (and also CE03) requirements, Gaia Converter can propose a stand-alone ready-to-use EMI filter module. This EMI filter module has to be used together with a common mode noise capacitance C_c (10nF/rated voltage depending on isolation requirement) connected between G_{in} and G_{out} .

EMI Filter module reference : FGDS-2A-50V.
Please consult EMI filter datasheet for further details.

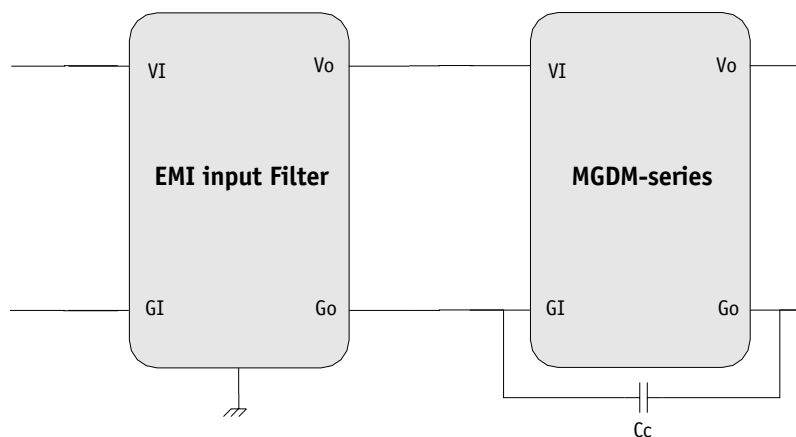

9- Thermal Characteristics

Characteristics	Conditions	Limit or typical	Performances
Operating ambient temperature range at full load	Ambient temperature *	Minimum Maximum	- 40°C + 85°C
Operating case temperature range at full load	Case temperature	Minimum Maximum	- 40°C +105°C
Storage temperature range	Non functioning	Minimum Maximum	- 55°C + 125°C
Thermal resistance	Rth case to ambient in free air natural convection	Typical	12°C /W

Note * : The upper temperature range depends on configuration, the user must assure a max. case temperature of + 105°C.

The MGDM-10 series operating **case** temperature must not exceed 105°C. The maximum **ambient** temperature admissible for the DC/DC converter corresponding to the maximum operating case temperature of 105°C depends on the ambient airflow, the mounting/orientation, the cooling features and the power dissipated.

To calculate a maximum admissible ambient temperature the following method can be used. Knowing the maximum case temperature Tcase = 105°C of the module, the power used Pout and the efficiency η :

- determine the power dissipated by the module P_{diss} that should be evacuated :

$$P_{diss} = P_{out}(\frac{1}{\eta} - 1)$$

- determine the maximum ambient temperature :

$$T_a = 105^{\circ}\text{C} - R_{th} \times P_{diss}$$

where **Rth** is the thermal resistance from the case to ambient.

The previous thermal calculation shows two areas of operation :

- a normal operation area in a free natural ambient convection (grey area in this following graph),
- an area with cooling features (air flow or heatsink) ensuring a maximum case temperature below the maximum operating case temperature of 105°C (white area in the following graph).

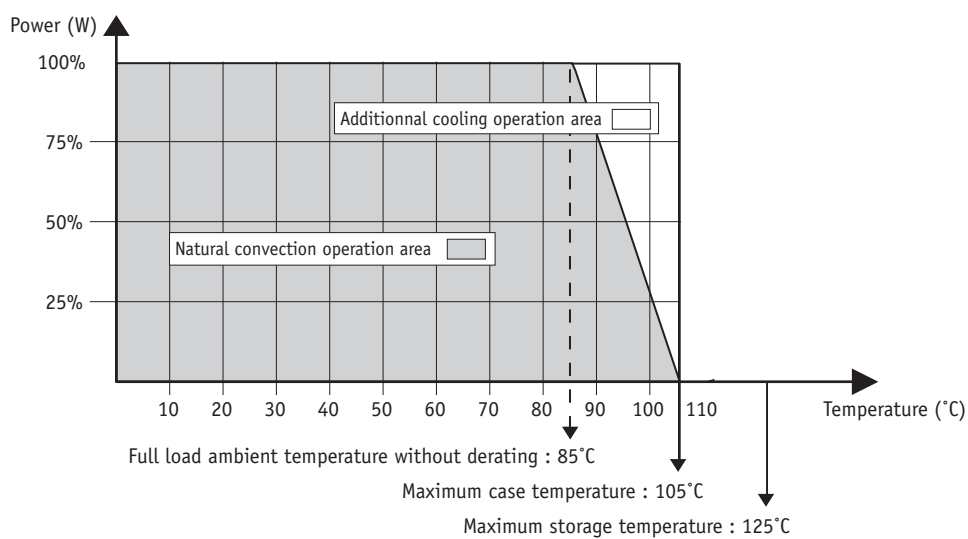

10- Environmental Qualifications

The modules have been subjected to the following environmental qualifications.

Characteristics	Conditions	Severity	Test procedure
Climatic Qualifications			
Life at high temperature	Duration Temperature / status of unit	Test D : 1.000 Hrs @ 105°C case, unit operating @ 125°C ambient, unit not operating	MIL-STD-202G Method 108A
Altitude	Altitude level C Duration Climb up Stabilization Status of unit	40.000 ft@-55°C 30 min. 1.000 ft/min to 70.000 f@-55°C, 30 min. unit operating	MIL-STD-810E Method 500.3
Humidity cyclic	Number of cycle Cycle duration Relative humidity variation Temperature variation Status of unit	10 Cycle I : 24 Hrs 60 % to 88 % 31°C to 41°C unit not operating	MIL-STD-810E Method 507.3
Humidity steady	Damp heat Temperature Duration Status of unit	93 % relative humidity 40°C 56 days unit not operating	MIL-STD-202G Method 103B
Salt atmosphere	Temperature Concentration NaCl Duration Status of unit	35°C 5 % 48 Hrs unit not operating	MIL-STD-810E Method 509.3
Temperature cycling	Number of cycles Temperature change Transfert time Steady state time Status of unit	200 -40°C / +85°C 40 min. 20 min. unit operating	MIL-STD-202A Method 102A
Temperature shock	Number of shocks Temperature change Transfert time Steady state time Status of unit	100 -55°C / +105°C 10 sec. 20 min. unit not operating	MIL-STD-202G Method 107G
Mechanical Qualifications			
Vibration (Sinusoidal)	Number of cycles Frequency / amplitude Frequency / acceleration Duration Status of unit	10 cycles in each axis 10 to 60 Hz / 0.7 mm 60 to 2000 Hz / 10 g 2h 30 min. per axis unit not operating	MIL-STD-810D Method 514.3
Shock (Half sinus)	Number of shocks Peak acceleration Duration Shock form Status of unit	3 shocks in each axis 100 g 6 ms 1/2 sinusoidal unit not operating	MIL-STD-810D Method 516.3
Bump (Half sinus)	Number of bumps Peak acceleration Duration Status of unit	2000 bumps in each axis 40 g 6 ms unit not operating	MIL-STD-810D Method 516.3

11- Description of Protections

11-1 Input Undervoltage Lock-out (UVLO)

The input undervoltage lock-out protection device turns-on and turns-off the output voltage when the input bus voltage reaches the undervoltage lock-out threshold. There is no hysteresis cycle at turn-on and turn-off.

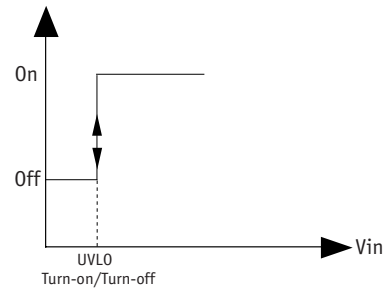

11-2 Output Short Circuit Protection (SCP)

The short circuit protection device protects the module against short circuit of any duration and restores the module to normal operation when the short circuit is removed. It operates in «hiccup» mode by testing periodically if an overload is applied (typically every 200ms recovery time). The overload detection threshold is typically 200% of maximum current with a detection time lower than 5ms.

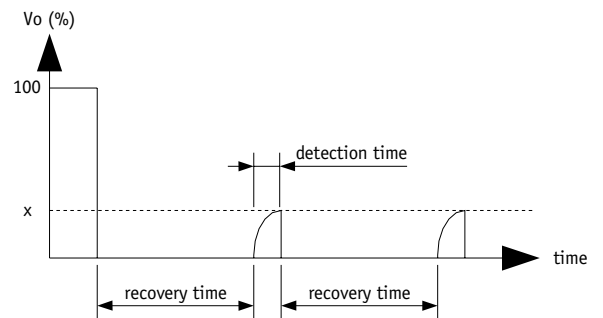

11-3 Output Overvoltage Protection (OVP)

The output overvoltage protection device protects external components against high voltage or possible overvoltages which can be supplied by the module (i.e in case of internal failure). It consists of a zener diode clamping the output voltage; under worst case conditions this zener diode will short-circuit.

The output voltage protection is not designed to withstand externally applied output overvoltages to protect the module itself.

12- Description of Functions

12-1 Option (/M) : On/Off Function

The optionnal control pin A (On/Off) can be used for applications requiring On/Off operation. By using an open collector command with a transistor Q referenced to the common terminal (Gi) :

- A logic pulled low (<0.2V@1mA, referenced to Gi) on pin A disables the converter
- No connection or high impedance on pin A enables the converter.

By releasing the On/Off function, the converter will restart within the start-up time specifications given in table page 3. For further details please consult "Logic On/Off" Application Note.

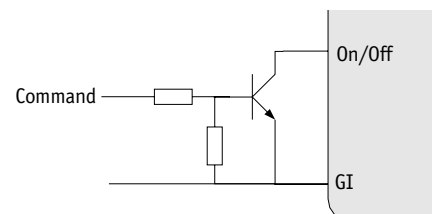

13- Application Notes

13-1 Connection of Outputs in Series

Any of the bi output converters can be configured to produce an output of 10V (+/-5 output models), 24V (+/-12V output models), or 30V (+/-15V output models) by connecting the load across the output (+) and the output (-) with either output grounded, and leaving the common pin floating.

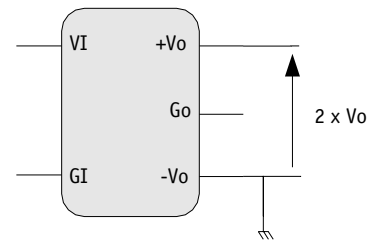

13-2 Connection of Modules in Series

The output of single output units can be connected in series without any precautions to provide higher output voltage level.

Nevertheless, GAIA Converter recommends to protect each individual output by a low power shottky diode rated with the maximum current of the converter to avoid reverse polarity at any output.

Reverse polarity may occur at start up if the output voltages do not rise at the same time.

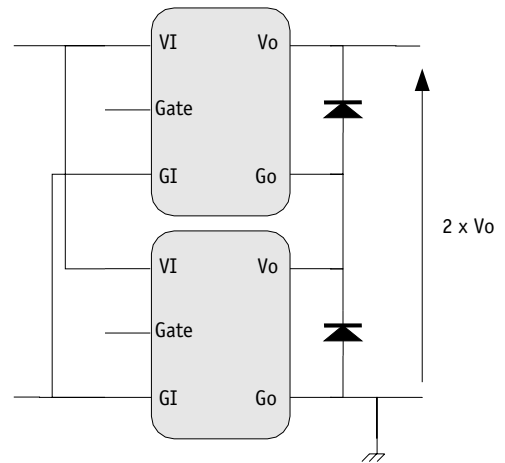

13-3 Connection of Modules in Parallel

The MGDM-10 series feature a current share function. Several converters with equal output voltage can be connected in parallel to increase power.

A «master» module will synchronize a «slave» module to the same clock allowing a current share in between modules through the «gate» pin.

A master module MGDS-10 can drive up to 2 slave modules MGDE-10 .

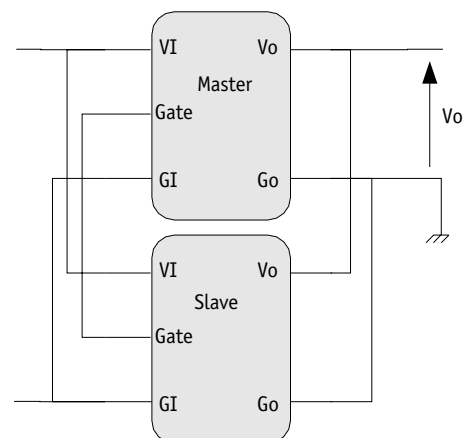

14- Dimensions

Dimension are given in mm (inches). Tolerance : +/- 0,2 mm (+/- 0.01 ") unless otherwise indicated.
 Weight : 20 grams (0.7 Ozs) max.

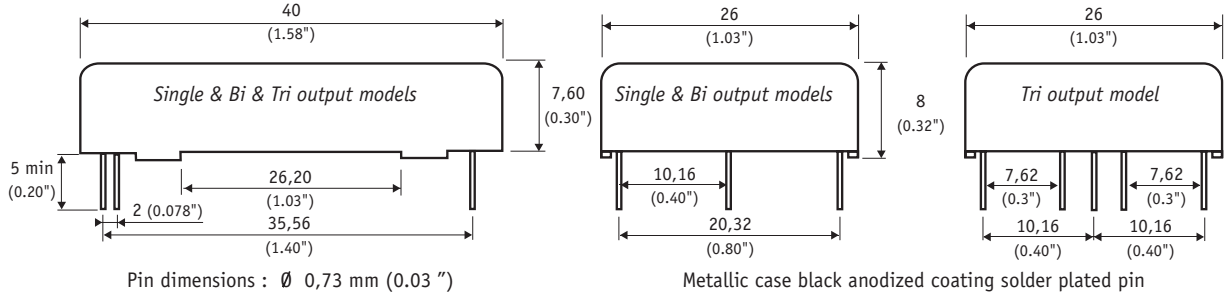

15- Product Marking

Upper face : Company logo, location of manufacturing.
 Side face : Module reference, option, date code : year and week of manufacturing.

4

16- Connections

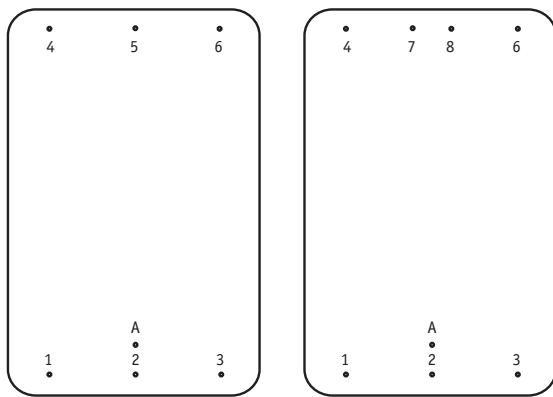

Single & Bi output models

Tri output models

Bottom view

Pin	Single	Bi	Triple
1	+ Input (Vi)	+ Input (Vi)	+ Input (Vi)
2	Gate	No pin	No pin
3	- Input (Gi)	- Input (Gi)	- Input (Gi)
4	Output (Vo)	Output + (+Vo)	Output 1 (V1)
5	No pin	Common (Go)	/
6	Common (Go)	Output - (-Vo)	Common (Go)
7	/	/	Output 2+ (+V2)
8	/	/	Output 2- (-V2)
A	No pin *	No pin *	No pin *

* Option /M : Pin A existing for On/Off function.
 Please add /M to module reference.



For more detailed specifications and applications information, contact :

International Headquarters

GAÏA Converter - France
ZI de la Morandière
33185 LE HAILLAN - FRANCE
Tel. : + (33)-5-57-92-12-80
Fax : + (33)-5-57-92-12-89

North American Headquarters

GAÏA Converter Canada, Inc
4038 Le Corbusier Blvd
LAVAL, QUEBEC - CANADA H7L 5R2
Tel. : (514)-333-3169
Fax : (514)-333-4519

Represented by :